

SPECIFICATION FOR APPROVAL

REF : 20080502-H

PAGE: 1

PROD. NAME	WOUND CHIP INDUCTOR	ABC'S DWG NO.	CM3225□□□□L□-□□□
		ABC'S ITEM NO.	

. CONFIGURATION & DIMENSIONS :

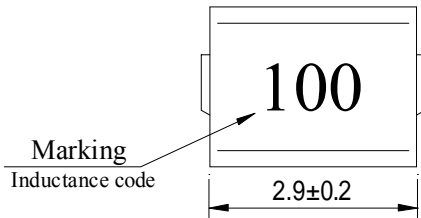

- A : 3.2±0.4 m/m
- B : 2.5±0.2 m/m
- C : 2.2±0.2 m/m
- E : 1.0±0.2 m/m
- F : 0.6^{+0.3}₀ m/m
- K = K1-K2 = 0.25⁺⁰ m/m

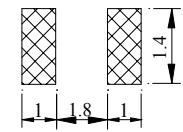
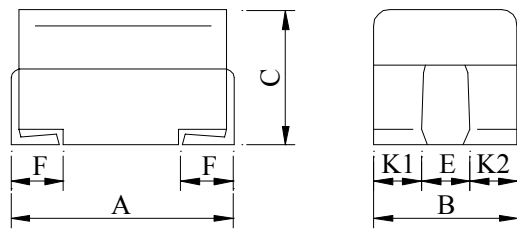

(PCB Pattern)

. SCHEMATIC DIAGRAM :

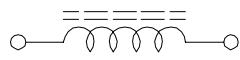

. MATERIALS :

- a . Core : Ferrite DR core
- b . Wire : Enamelled copper wire (class H)
- c . Terminal : Cu/Sn
- d . Encapsulate : Epoxy novolac molding compound
- e . Remark : Products comply with RoHS' requirements

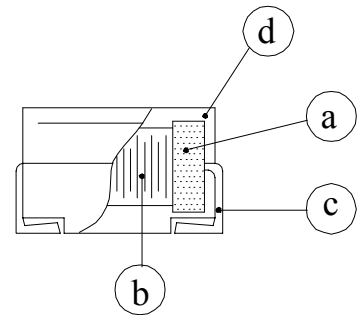

. GENERAL SPECIFICATION :

- a . Temp. rise : 20 max.
- b . Ambient temp. : 100 max.
- c . Storage temp. : -40 ----+125
- d . Operating temp. : -40 ----+125
- e . Terminal pull strength : 1.5 kg min.
- f . Rated current : Current cause
inductance drop within 10%
- g . Resistance to solder heat : 260 .10 secs.
- h . Resistance to solvent : Per MIL-STD-202F

Reflow profile
 Peak Temp : 250 max.
 Max time above 245 : 20~40sec max.
 Max time above 217 : 60~150sec max.
 200 ~250 Average Ramp-up Rate : 3 /second max.

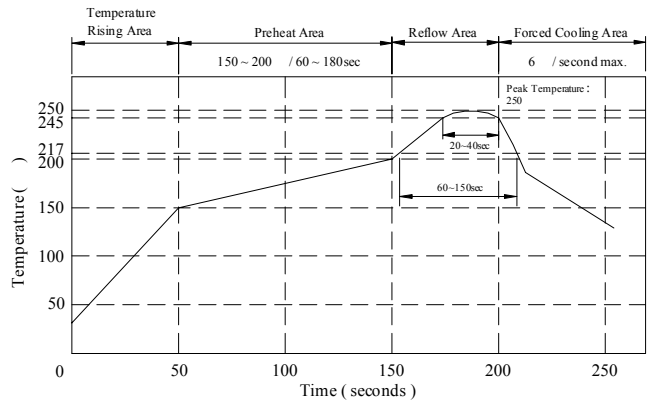

AR-001A

SPECIFICATION FOR APPROVAL

REF : 20080502-H

PAGE: 2

PROD. NAME	WOUND CHIP INDUCTOR	ABC'S DWG NO.	CM3225□□□□L□-□□□
		ABC'S ITEM NO.	

. ELECTRICAL CHARACTERISTICS :

DWG No.	Inductance (μH)	Q min.	Test Freq (MHz)	SRF (MHz) min.	RDC (Ω) max.	IDC (mA) max
CM3225R12ML□ -□□□	0.120±20%	30	25.2	500	0.22	450
CM3225R15ML□ -□□□	0.150±20%	30	25.2	450	0.25	450
CM3225R18ML□ -□□□	0.180±20%	30	25.2	400	0.28	450
CM3225R22ML□ -□□□	0.220±20%	30	25.2	350	0.32	450
CM3225R27ML□ -□□□	0.270±20%	30	25.2	320	0.36	450
CM3225R33ML□ -□□□	0.330±20%	30	25.2	300	0.40	450
CM3225R39ML□ -□□□	0.390±20%	30	25.2	250	0.45	450
CM3225R47ML□ -□□□	0.470±20%	30	25.2	220	0.50	450
CM3225R56ML□ -□□□	0.560±20%	30	25.2	180	0.55	450
CM3225R68ML□ -□□□	0.680±20%	30	25.2	160	0.60	450
CM3225R82ML□ -□□□	0.820±20%	30	25.2	140	0.65	450
CM32251R0KL□ -□□□	1.000±10%	30	7.96	120	0.70	400
CM32251R2KL□ -□□□	1.200±10%	30	7.96	100	0.75	390
CM32251R5KL□ -□□□	1.500±10%	30	7.96	85	0.85	370
CM32251R8KL□ -□□□	1.800±10%	30	7.96	80	0.90	350
CM32252R2KL□ -□□□	2.200±10%	30	7.96	75	1.00	320
CM32252R7KL□ -□□□	2.700±10%	30	7.96	70	1.10	290
CM32253R3KL□ -□□□	3.300±10%	30	7.96	60	1.20	260
CM32253R9KL□ -□□□	3.900±10%	30	7.96	55	1.30	250
CM32254R7KL□ -□□□	4.700±10%	30	7.96	50	1.50	220
CM32255R6KL□ -□□□	5.600±10%	30	7.96	45	1.60	200
CM32256R8KL□ -□□□	6.800±10%	30	7.96	40	1.80	180
CM32258R2KL□ -□□□	8.200±10%	30	7.96	35	2.00	170
CM3225100KL□ -□□□	10.000±10%	30	2.52	30	2.10	150
CM3225120KL□ -□□□	12.000±10%	30	2.52	20	2.50	140
CM3225150KL□ -□□□	15.000±10%	30	2.52	20	2.80	130
CM3225180KL□ -□□□	18.000±10%	30	2.52	20	3.30	120
CM3225220KL□ -□□□	22.000±10%	30	2.52	20	3.70	110
CM3225270KL□ -□□□	27.000±10%	30	2.52	20	5.00	80
CM3225330KL□ -□□□	33.000±10%	30	2.52	17	5.60	70
CM3225390KL□ -□□□	39.000±10%	30	2.52	16	6.40	65
CM3225470KL□ -□□□	47.000±10%	30	2.52	15	7.00	60
CM3225560KL□ -□□□	56.000±10%	30	2.52	13	8.00	55
CM3225680KL□ -□□□	68.000±10%	30	2.52	12	9.00	50
CM3225820KL□ -□□□	82.000±10%	30	2.52	11	10.00	45
CM3225101KL□ -□□□	100.000±10%	20	0.796	10	11.00	40
CM3225121KL□ -□□□	120.000±10%	20	0.796	10	11.00	70
CM3225151KL□ -□□□	150.000±10%	20	0.796	8	15.00	65

- 1). □ : Packaging information . . . [A]: Bulk [B]: Taping Reel
 2). "- □□□ " : Reference code

AR-001A



SPECIFICATION FOR APPROVAL

REF : 20080502-H

PAGE: 3

PROD. NAME	WOUND CHIP INDUCTOR	ABC'S DWG NO.	CM3225□□□□L□-□□□
		ABC'S ITEM NO.	

. CURVE :

@ Inductance VS. DC Superposition Characteristics

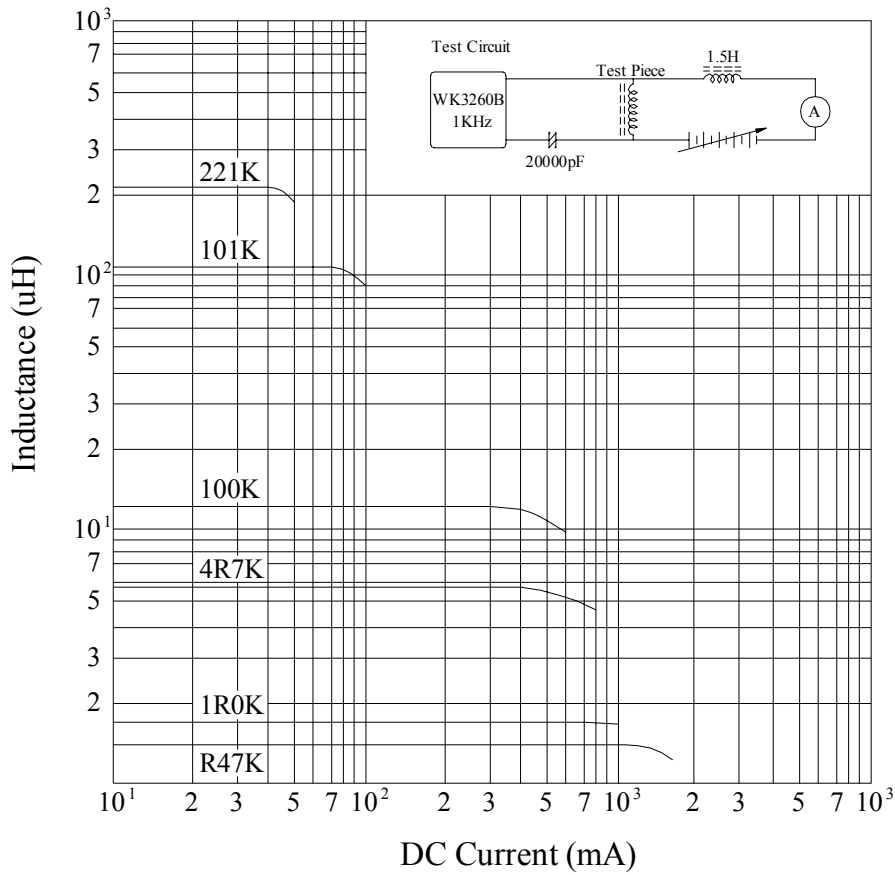

@ Q VS. Frequency Response

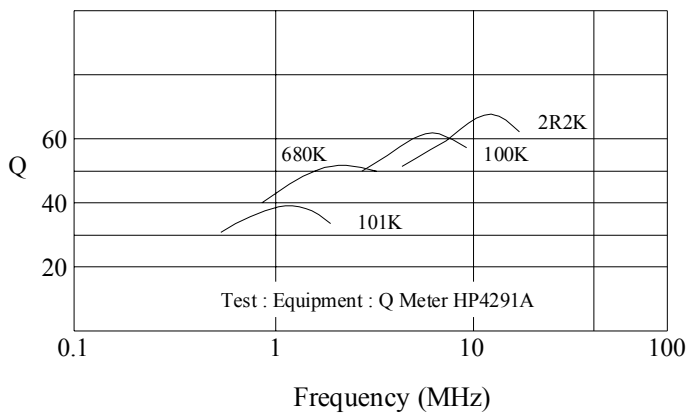

@ Inductance Change VS. Temperature Response

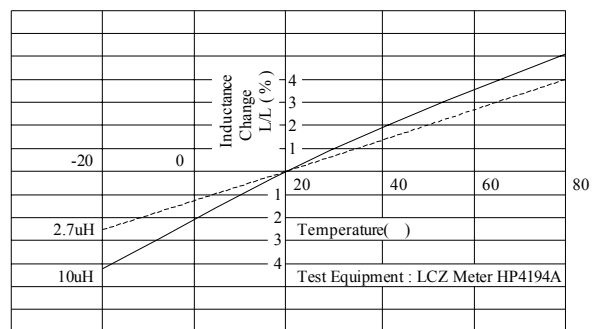

AR-001A

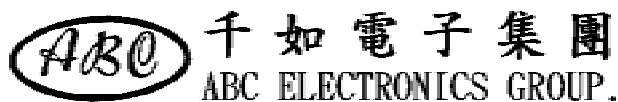

SPECIFICATION FOR APPROVAL

REF : 20080502-H

PAGE: 4

PROD. NAME	WOUND CHIP INDUCTOR	ABC'S DWG NO.	CM3225□□□□L□-□□□
		ABC'S ITEM NO.	

PACKAGING INFORMATION :

(1) Configuration

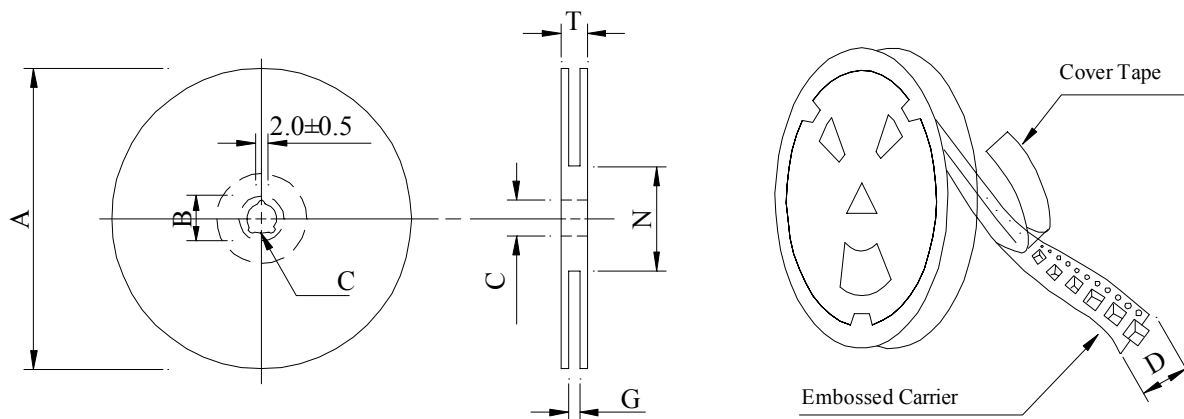

Carrier Tape Width : D

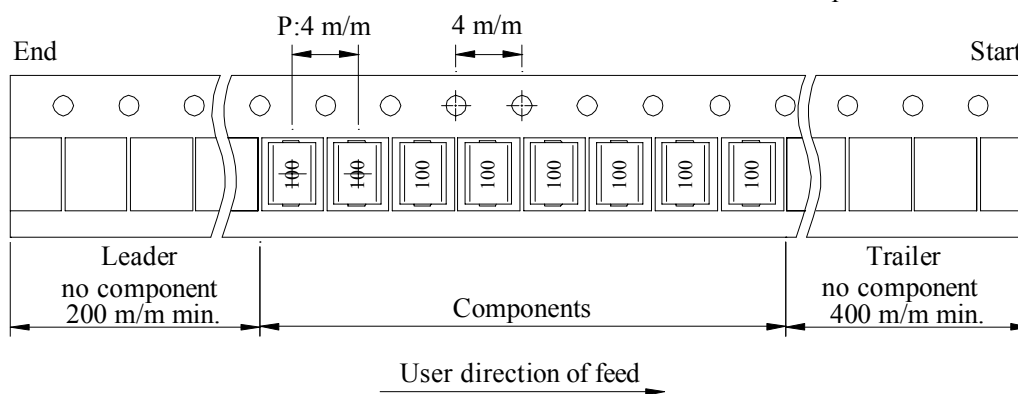

There is no differentiation or directions of polarity (marking) in the packaging method.

(2) Dimensions

Unit:m/m

Style	A	B	C	D	G	N	T
07 - 08	178	21±0.8	13	8	10 ⁺⁰	50 ⁻⁰	12.5
07(S) - 08	183	21±0.8	13	8	10 ⁺⁰	50 ⁻⁰	12.5
13 - 08	330	21±0.8	13±0.5	8	10 ⁺⁰	50 ⁻⁰	12.5

(3) Q'TY & G.W. Per package

Series	Inner : Reel			Outer : Carton		
	Q'TY (pcs)	G.W. (gw)	Style	Q'TY (pcs)	G.W. (Kg)	Size (cm)
CM3225	1,000	110	07 - 08	50,000	7.50	41 x 39 x 22
CM3225	2,000	220	07(S) - 08	100,000	15.00	41 x 39 x 22
CM3225	7,000	770	13 - 08	84,000	9.80	41 x 39 x 22

AR-001A

SPECIFICATION FOR APPROVAL

REF : 20080502-H

PAGE: 5

PROD. NAME	WOUND CHIP INDUCTOR	ABC'S DWG NO.	CM3225□□□□L□-□□□
		ABC'S ITEM NO.	

. DWGING NUMBER EXPRESSION :

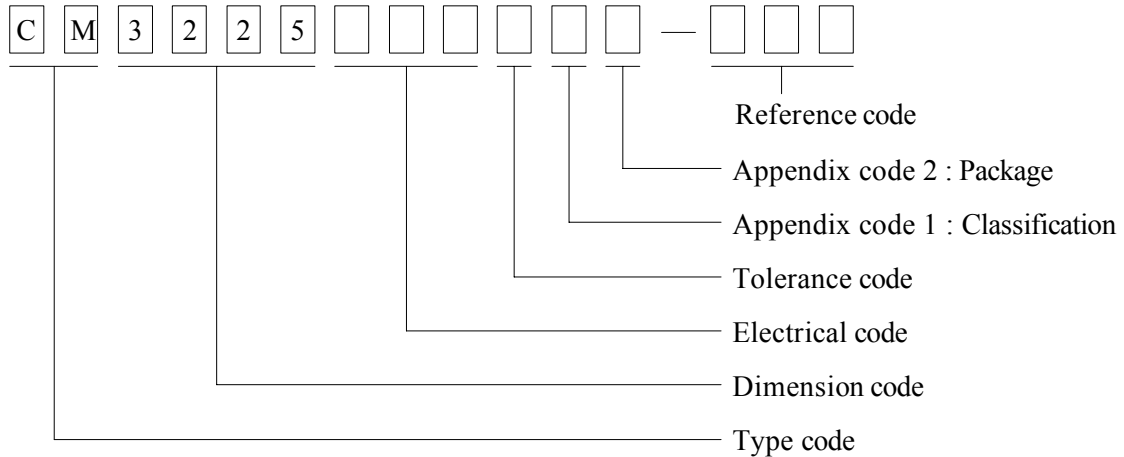

Appendix code 1 : Product Classification

L : Lead Free Standard products comply with RoHS' requirements

1 ~ 9 : Lead Free Special products comply with RoHS' requirements

Appendix code 2 : Package Information

Code	Inner package	Inner package Q'TY	Remark
A	Bag	1000 pcs	
B	T / R (Reel package)	1000 pcs	
C	T / R (Reel package)	2000 pcs	[anti-static]
D	T / R (Reel package)	7000 pcs	Hot-press
E	T / R (Reel package)	1000 pcs	[anti-static]
F	T / R (Reel package)	2000 pcs	

Note : ① package code "B" & "C" & "E" :

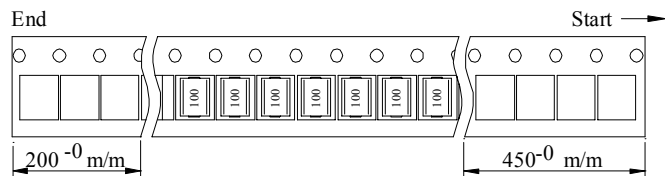

Note : ② package code "F" :

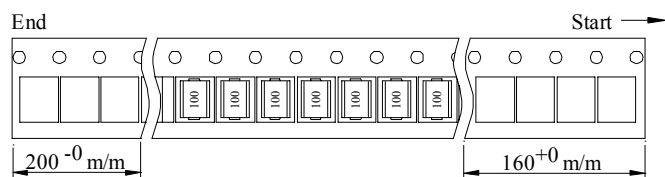

AR-001A

SPECIFICATION FOR APPROVAL

REF : 20080502-H

PAGE: 6

PROD. NAME	WOUND CHIP INDUCTOR	ABC'S DWG NO.	CM3225□□□□L□-□□□
		ABC'S ITEM NO.	
. RELIABILITY TEST :			
Test item	Specification	Test condition / Test method	
● Electrical performance test			
Inductance L	Refer to standard electrical characteristic list	□HP4194A with HP-16034E test fixture	
Q			
Self resonance frequency SRF		□HP4291A with HP-16093A test fixture	
DC Resistance RDC		CH-502AC	
Rated current IDC		Applied the current to coils , The Inductance change shall be less than 10% to initial value & temperature rise shall not be more than 20	
Temperature rise test	20 max.	1 . Applied the allowed DC current for 10 minutes 2 . Temperature measure by digital surface thermometer	
Over load test	After test , Inductors shall be no evidence of electrical and mechanical damage	Applied 2 times of rated allowed DC current to inductor for a period of 5 minutes	
Withstanding voltage test	After tset , Inductors shall be no evidence of electrical and mechanical damage	AC voltage of 1000VAC applied between inductors terminal and coating for 5 seconds	
Insulation resistance test	1000 MΩ min .	100 VDC applied between inductor terminal and coating	
● Mechanical performance test			
Vibration test (Low frequency)	1 . Inductors shall be no evidence of electrical and mechanical damage 2 . Inductance shall not change more than±5% 3 . Q Shall not change more than ±20%	1 . Amplitude : 1.5 m/m 2 . Frequency : 10 -- 55 -- 10 Hz / 1min. 3 . Direction : X , Y , Z 4 . Duration : 2 hrs / X , Y , Z	
Shock test		Inductors shall be dropped 10 times from a height of 1m onto 3cm wooden board	
Resistance to soldering heat		Temp : 260±5 Time : 10±1.0 sec.	

AR-001A

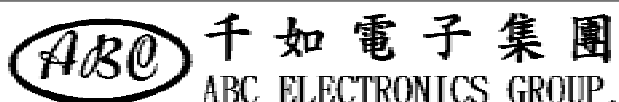

SPECIFICATION FOR APPROVAL

REF : 20080502-H

PAGE: 7

PROD. NAME	WOUND CHIP INDUCTOR	ABC'S DWG NO.	CM3225□□□□L□-□□□
		ABC'S ITEM NO.	
Terminal strength-pull test	Terminal shall not be loosened or ruptured	A 0.5kg load shall be applied to both Terminals in the axis direction for 1 minute .	
Solderability test	The terminal shall be at least 90% covered with solder	After fluxing , Inductor shall be dipped in a melted solder bath at 240±5 for 5 seconds .	
Resistance to solvent test	There shall be no case deformation change in appearance or obliteration of marking	MIL-STD-202F , Method 215D	
● Climatic test			
Temperature characteristic	1 . Inductors shall be no evidence of electrical and mechanical damage 2 . Inductance shall not change more than ±10% 3 . Q shall not change more than ±20%	-40 -- +125	
Humidity test		1 . Temp : 40±2 2 . R.H. : 90 -- 95% 3 . Time : 96±2 hours	
Cold test		1 . Temp : -25±2 2 . Time : 96±2 hours	
Thermal shock test		<p style="text-align: center;">Total : 5 cycles</p>	
Dry heat test		1 . Temp : 85±2 2 . Time : 96±2 hours	
High temperature load life test	There shall be no evidence of short or open circuiting	1 . Temp : 85±2 2 . Time : 1000±12 hours 3 . Load : Allowed DC current	
Humidity load life		1 . Temp : 40±2 2 . R.H. : 90 -- 95% 3 . Time : 1000±12 hours 4 . Load : Allowed DC current	
● Note : Unless otherwise specified , Allow the specimen to stand at room temperature for 1 hour or more but not more than 2 hours , Measure the electrical and mechanical performances			

AR-001A

SPECIFICATION FOR APPROVAL

REF : 20080502-H

PAGE: 8

PROD. NAME	WOUND CHIP INDUCTOR	ABC'S DWG NO.	CM3225□□□□L□-□□□
		ABC'S ITEM NO.	

. UL CARD :

OBMW2 August 27, 1999

Magnet Wire-Component

ELEKTRISOLA (MALAYSLA) SDN BHD E143312

IALAN DAMN SATU IANDA BAIK 28750 BENTONG, PAHANG
DARUL MAKMUR MALAYSIA

Mtl Dsg	Mark Dsg	Coating Type		ANSI Typ	Temp Class
		BC	OC		
Estersol 160	E180	Polyesterimide (solderable)	—	MW-77	180
Amldester 200	A200	Polyesterimide	—	MW-74	200
Polysol-N 155	PN155	Polyurechane	Nylon	MW-80, MW-28	155, 100
Polysol 155	P155	Polyurechane	—	MW-79, MW-79	155, 130
Polysol 155g	Pg155	Polyurechane	—	MW-79	130
Polysol 155p	Pp155,Gp155	Polyurechane	—	MW-79	155
Polysol 160	P160	Polyurechane	—	MW-79	155
Polysol 180	P180	Polyurechane	—	MW-79	155
Polysol 170	P170 or G170	Polyurechane	—	MW-79	156
Polysol-N 180	PN180	Polyurechane	Nylon	—	180

Marking : Dompany name/nateriel designation or marked designation and factory identification on package ok reel

See General Information preceding These Recognitions
For use only in equipment where the acceptability of the combination is determined by Underwriters Laboratories Inc.

OMFZ2 March 4, 1994

Component-Plastics

CHANG CHUN PLASTICS CO LTD E59481 (S)

(F1-cont. from F card)

BM-21	ALL	0.79	94HB	50	50	50	—	—	—	—	—
BM-22	ALL	0.79	94HB	50	50	50	—	—	—	—	—
BM-23	ALL	0.79	94V-0	50	50	50	—	—	—	—	—
EME-1100	BK	0.84	94V-0	130	130	130	—	—	—	—	—
	BK	6.4	94V-0	130	130	130	—	—	—	—	—
EME-1200	BK	0.84	94V-0	130	130	130	—	—	—	—	—
	BK	6.4	94V-0	130	130	130	—	—	—	—	—
EME-5961C	BK	0.3	94V-0	130	130	130	—	—	—	—	—
	BK	3.1	94V-0	130	130	130	—	—	—	—	—

Reports: January 19, 1988: January 19, 1988: January 19, 1988: June 2, 1988;
June 2, 1998; June 2, 1988.

Replaces E59481C dated February 7, 1989. (Cont. on C1 card)

262854001 N7047 Underwriters Laboratories Inc.® D11/0018965